

Pattern — Unit 34 — Butterfly and bees game

Pattern — Unit 34 — Soup-can card holder contest

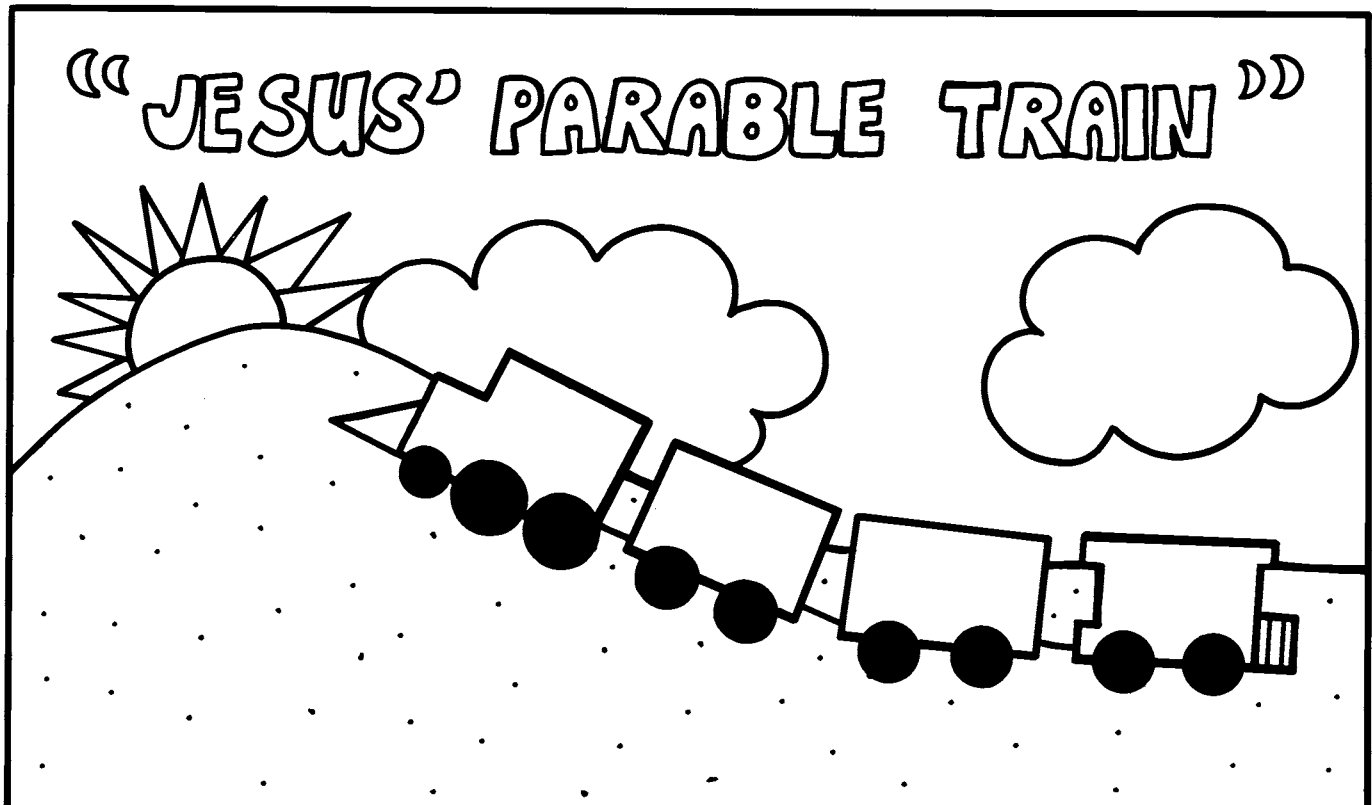

Pattern — Unit 34 — Jesus' Parable Train bulletin board

Jesus Told Some **FAB**ulous Stories
Called Parables!

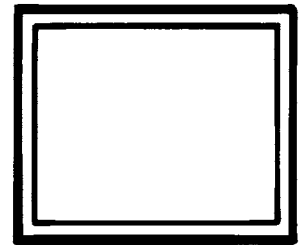
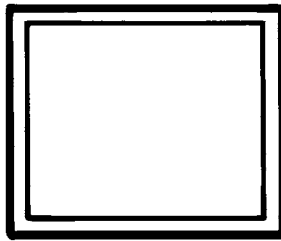
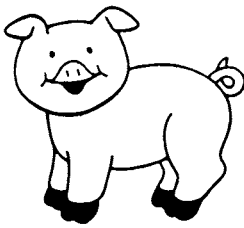
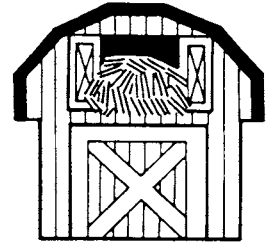
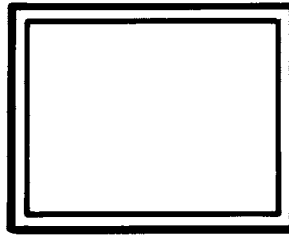
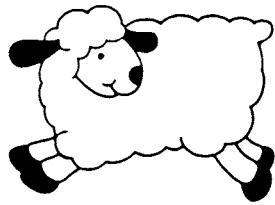
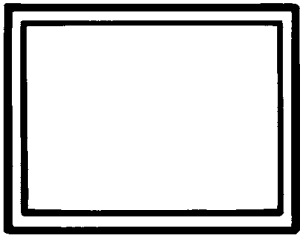

Pattern — Unit 34 — Soap labels bulletin board

LESSONS
FROM
LUKE

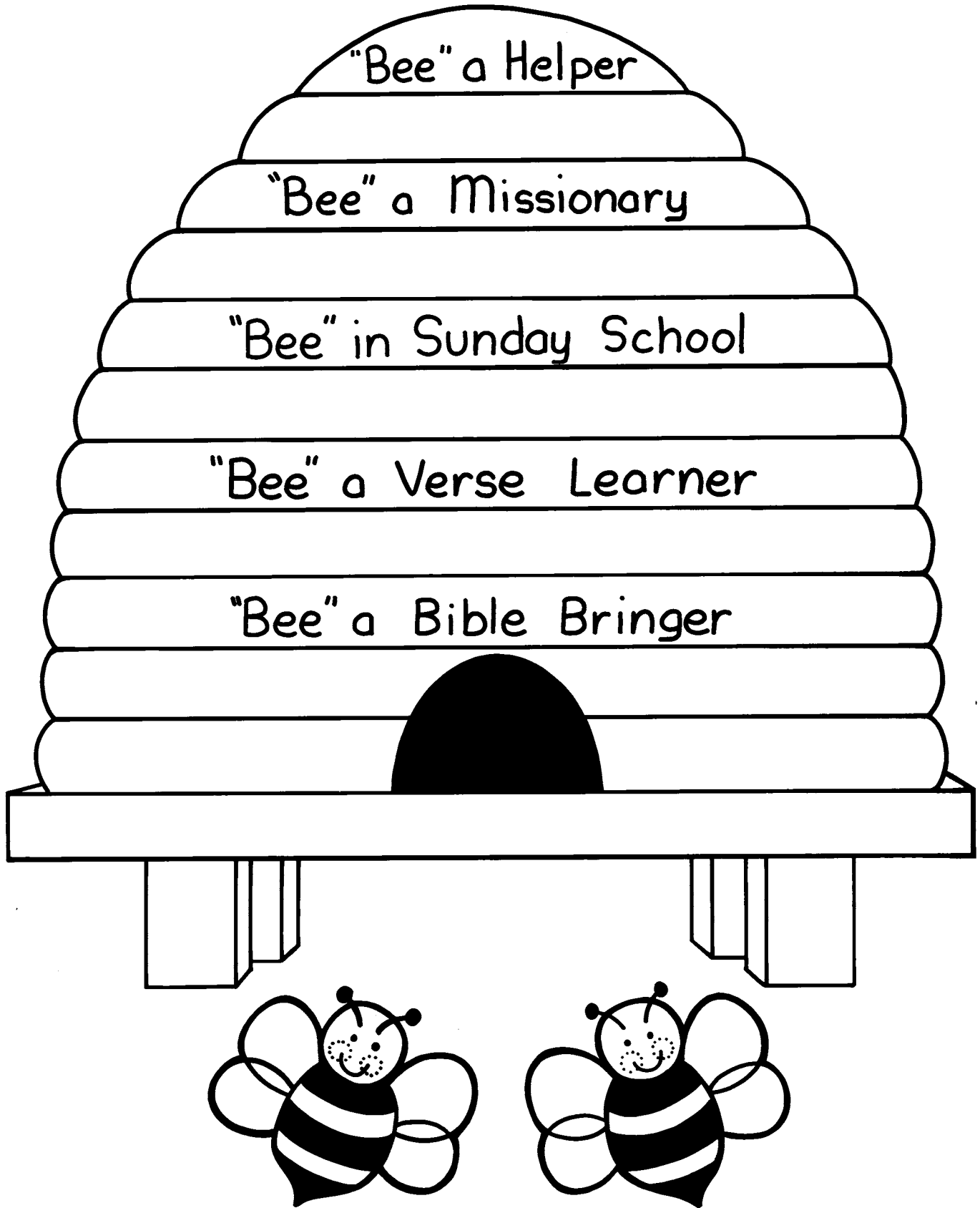

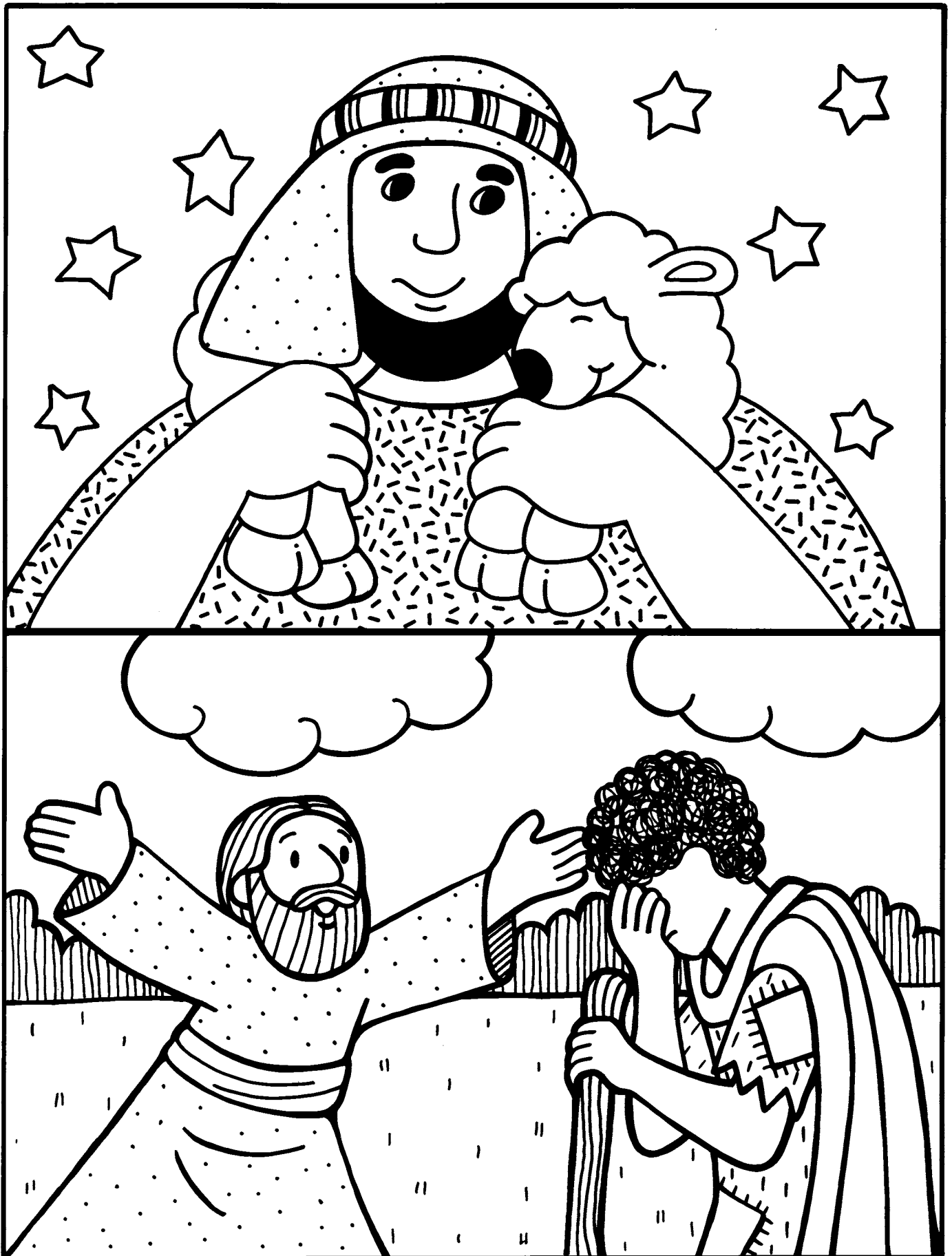

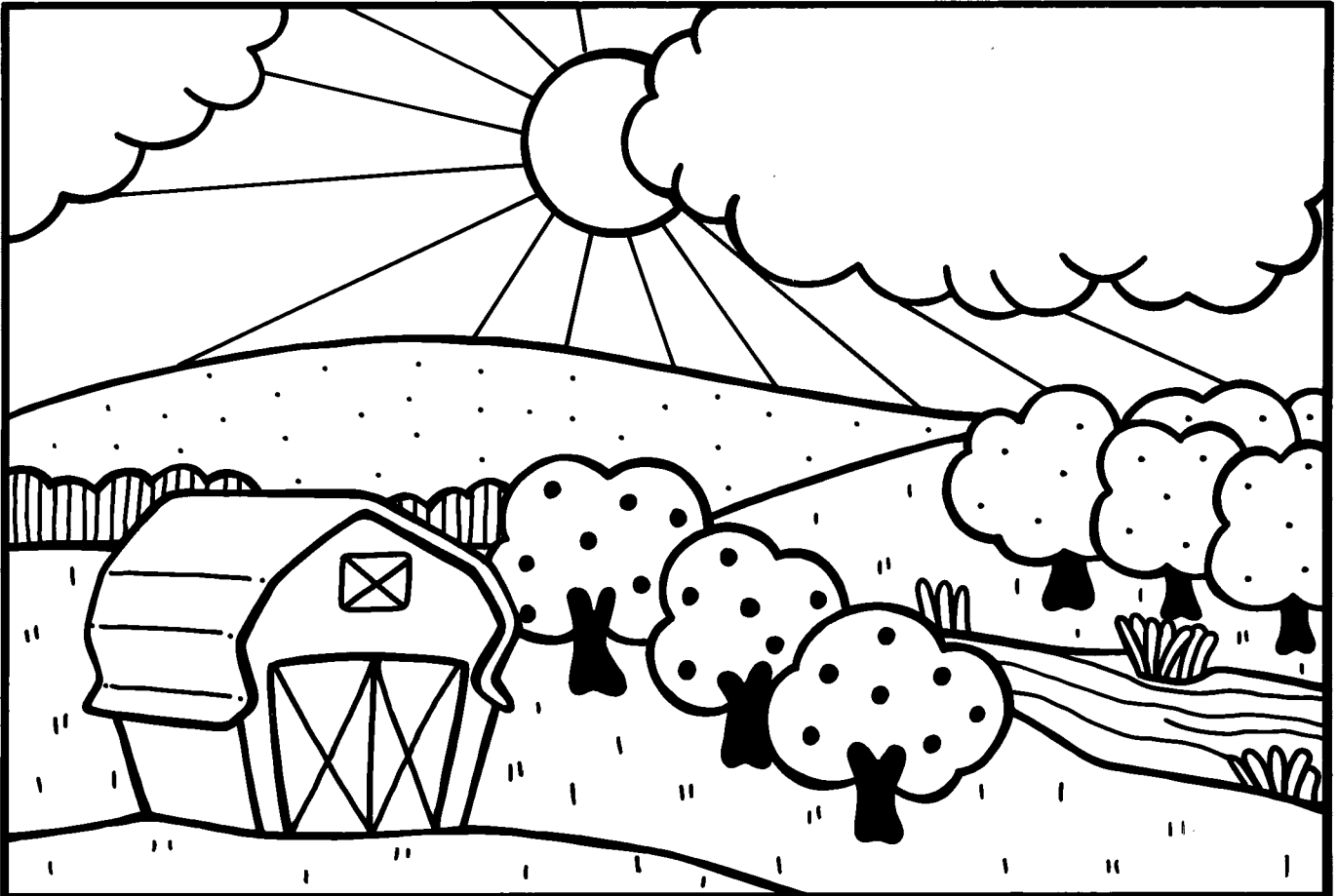

STORIES JESUS TOLD

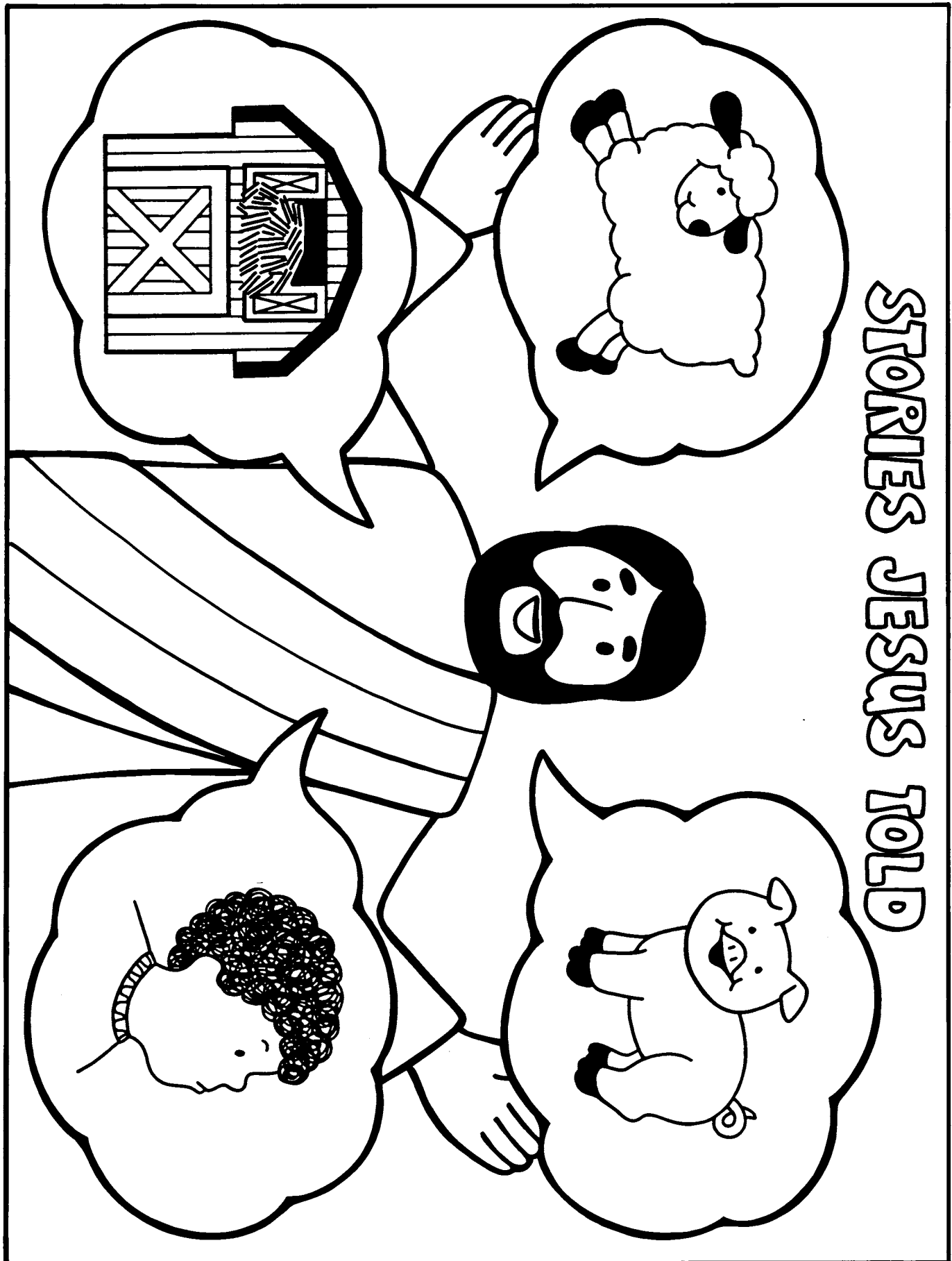

Stories

Jesus

Told

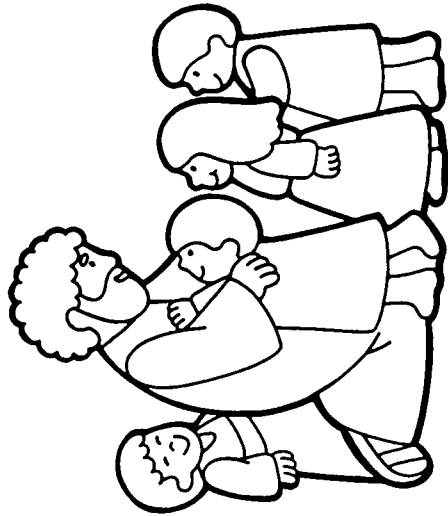

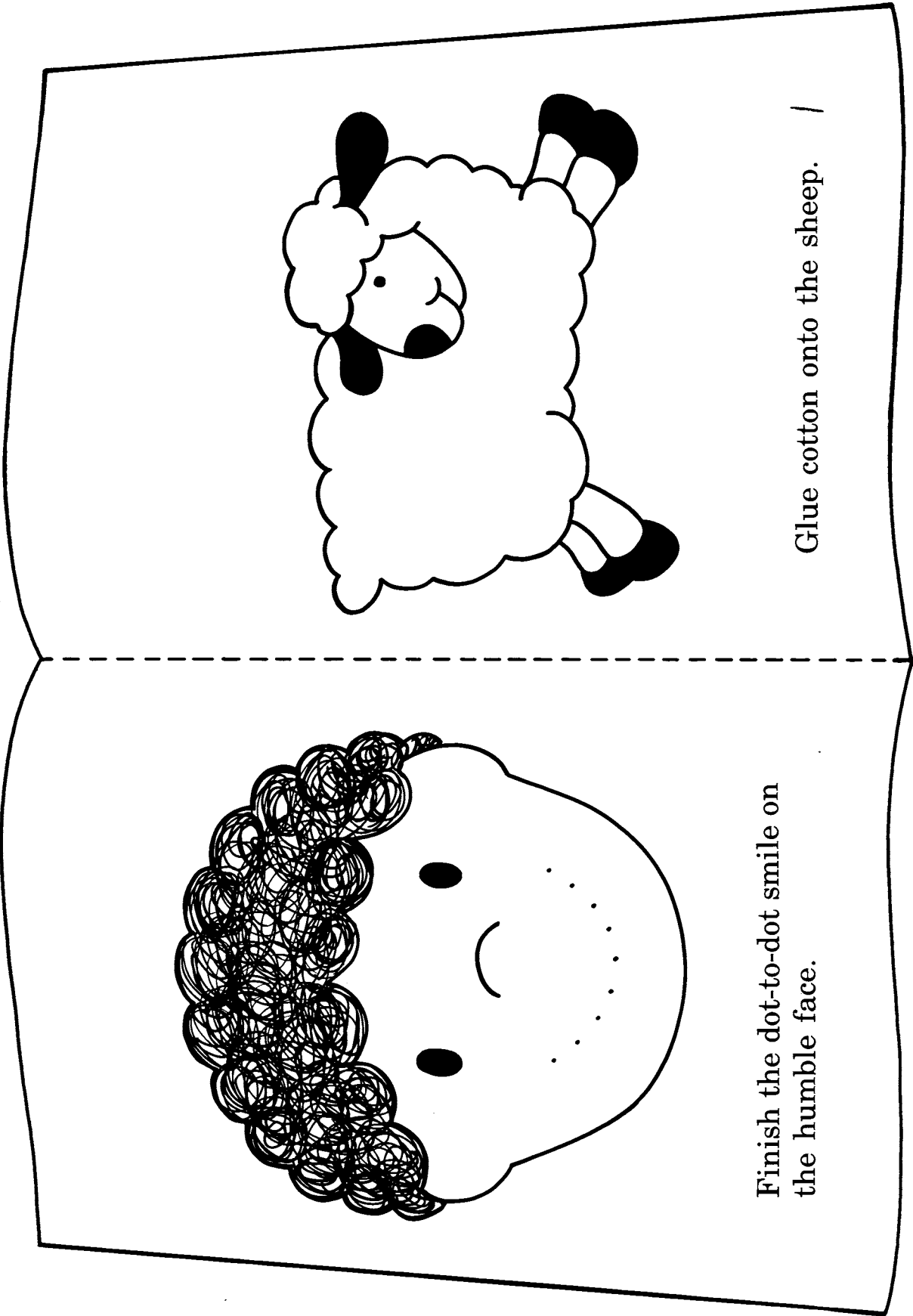

Finish the dot-to-dot smile on
the humble face.

Glue cotton onto the sheep. /

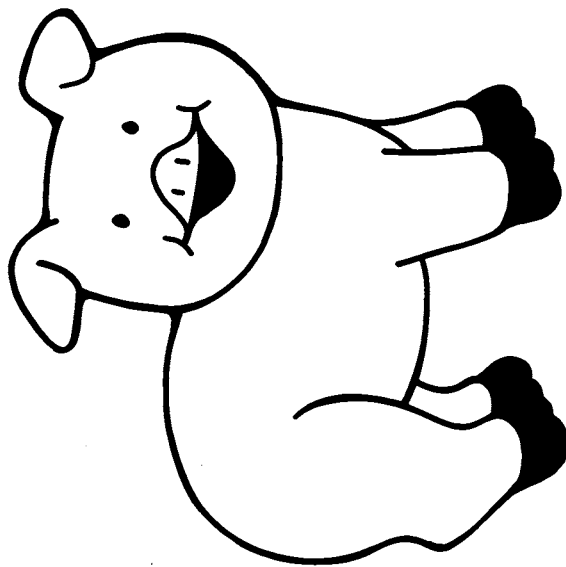

Draw curly tails on the pigs
or attach tails made from
curling ribbon.

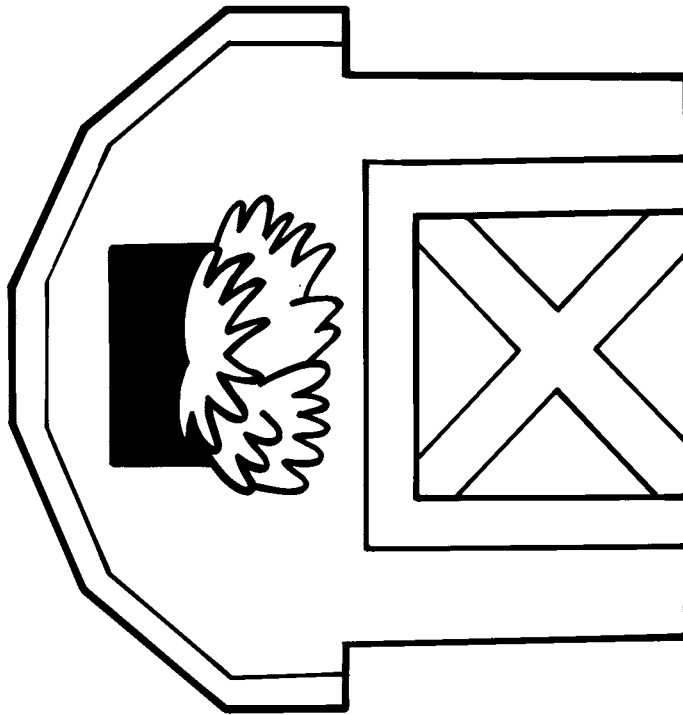

Attach animal and food
stickers to barn.

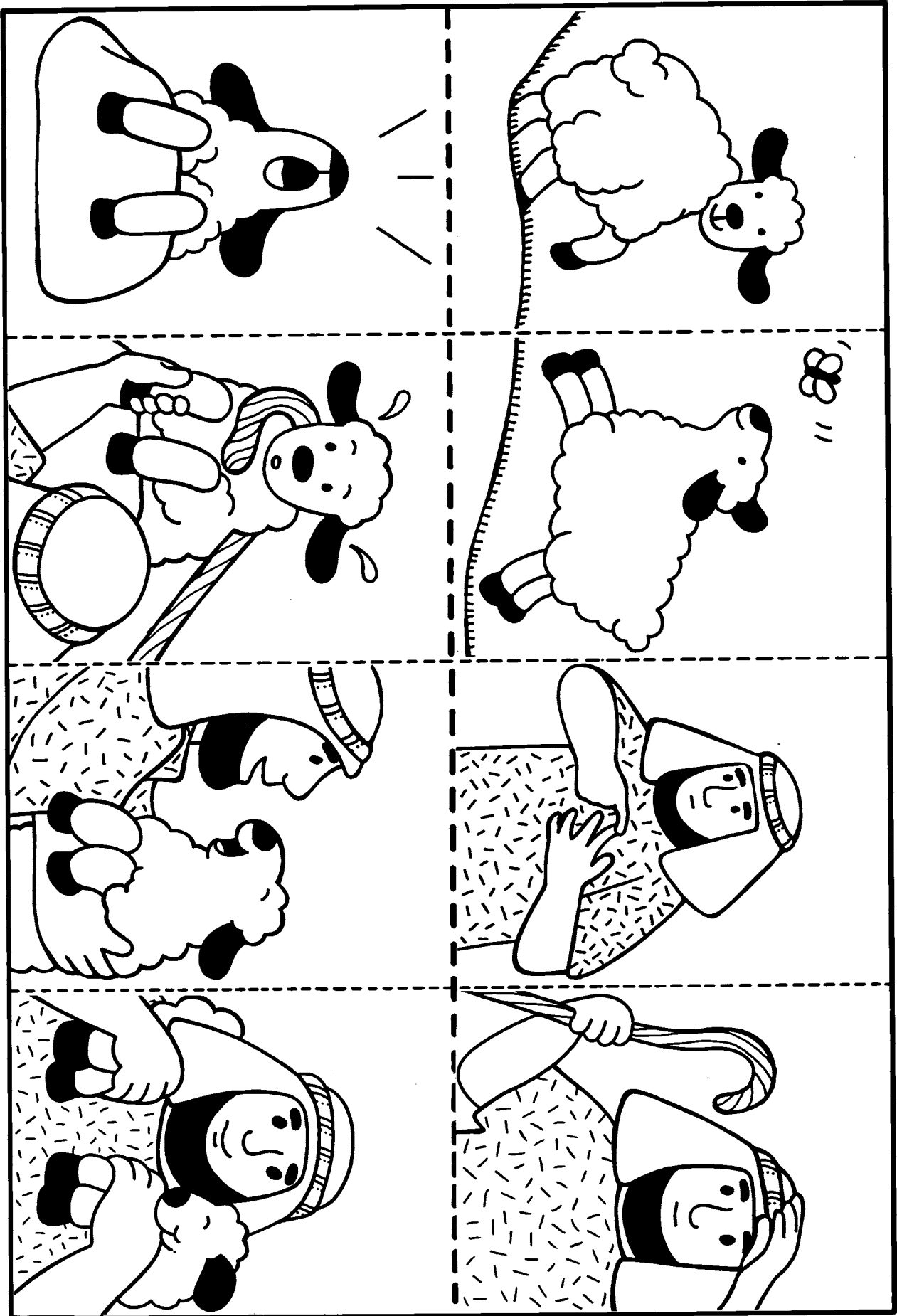

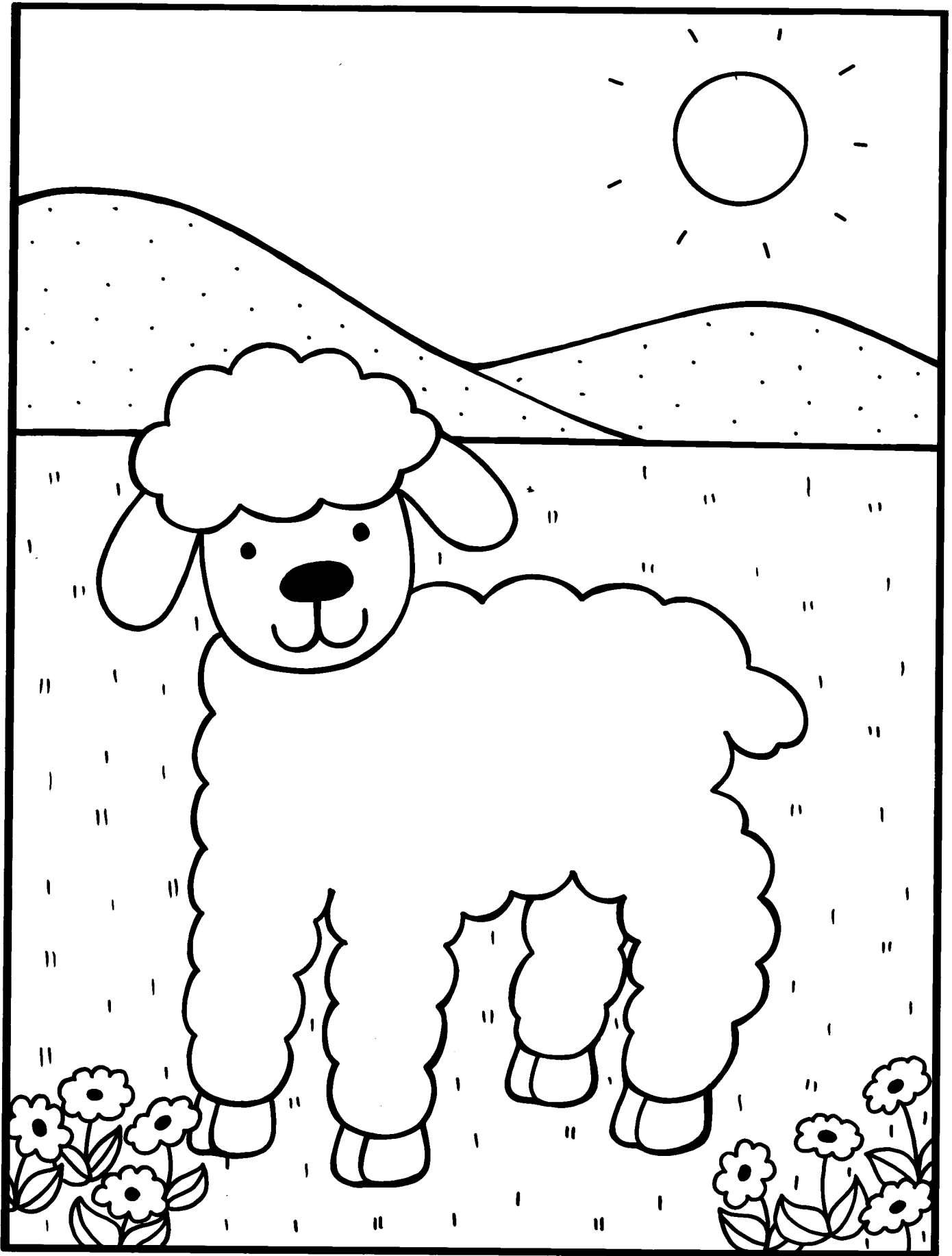

Pattern 34a — Lost lamb scribble picture

50a



Pattern 34a — Fold-over sheep



Pattern 34a — Jesus as Shepherd figure

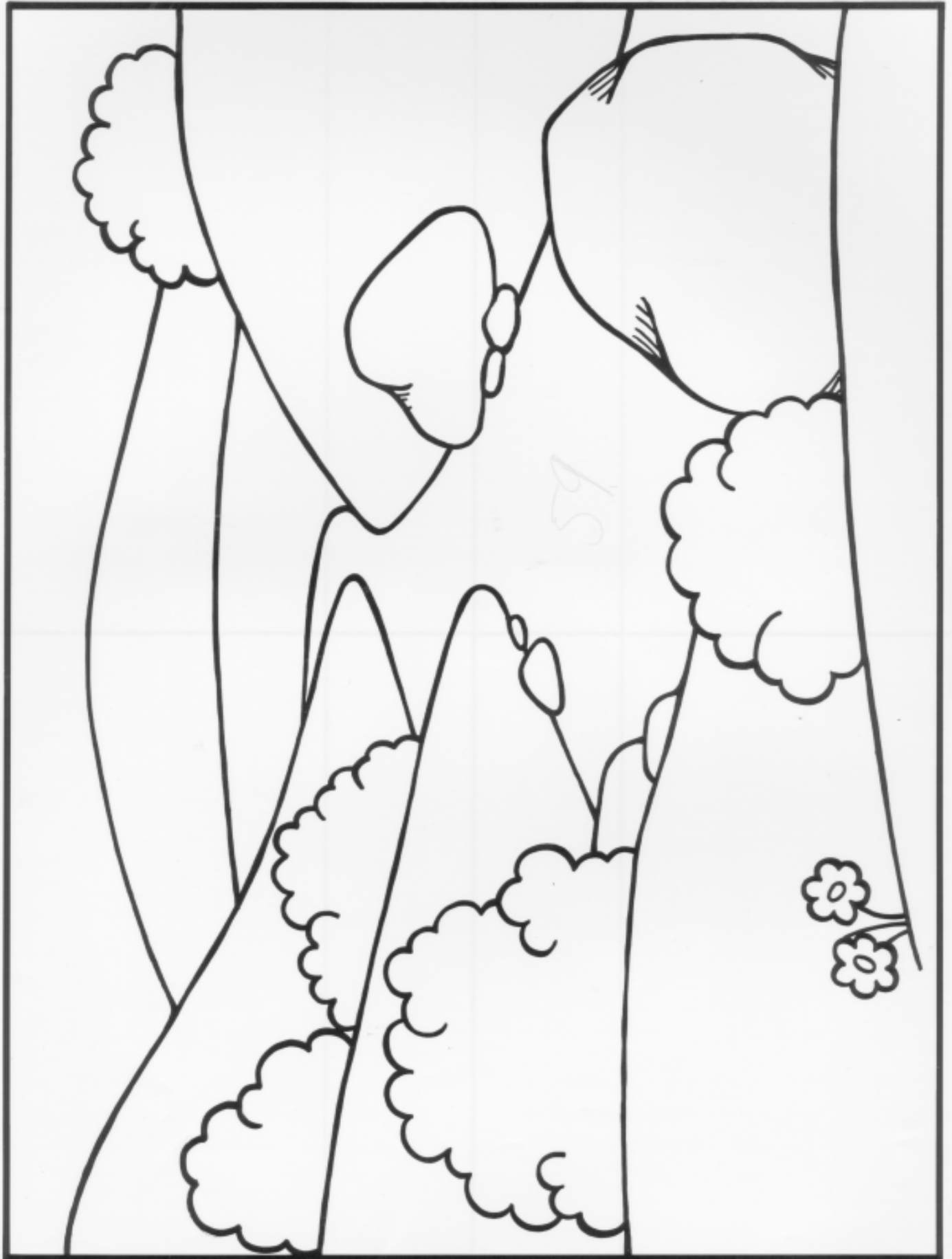

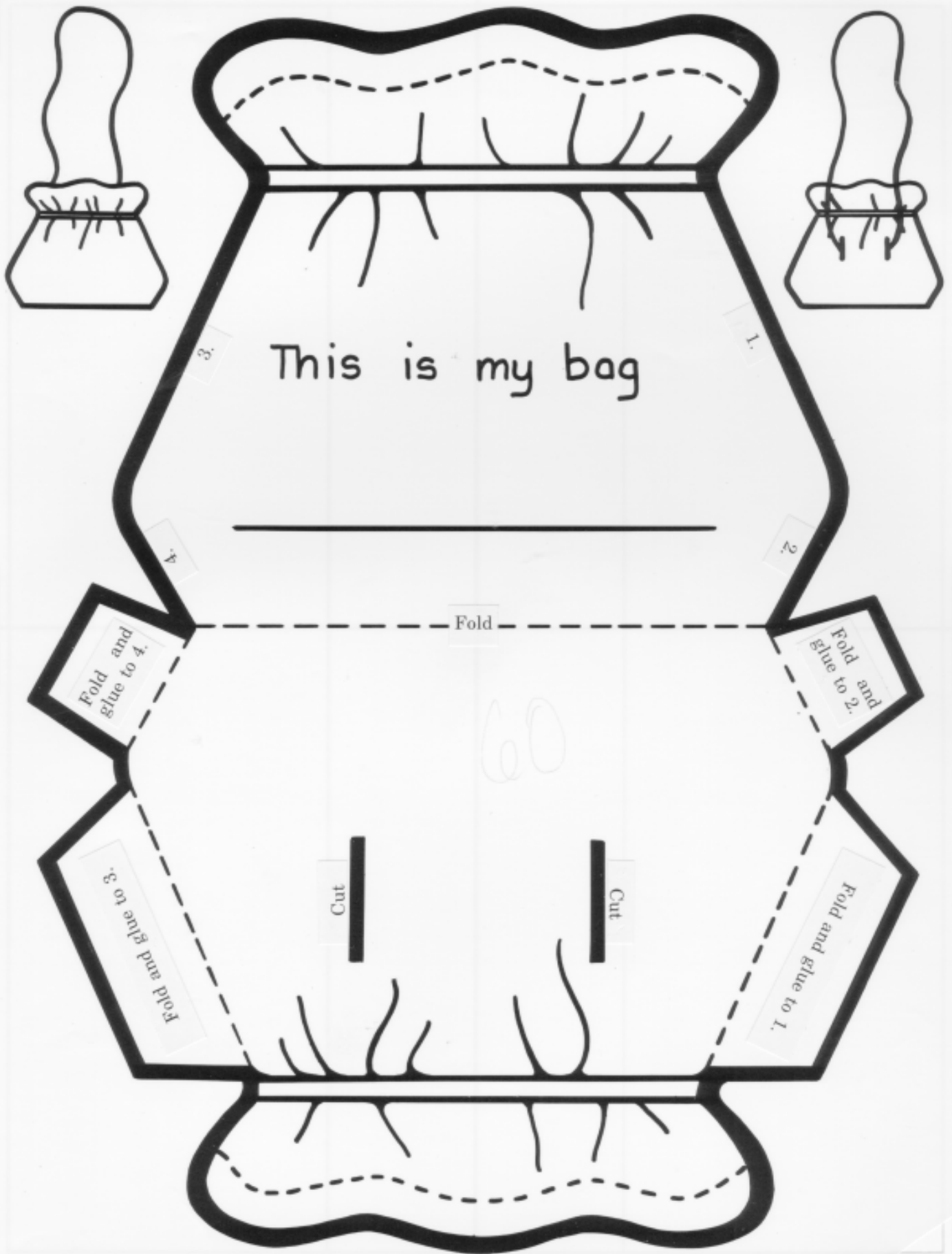



Pattern 34b — Figure of boy and coat

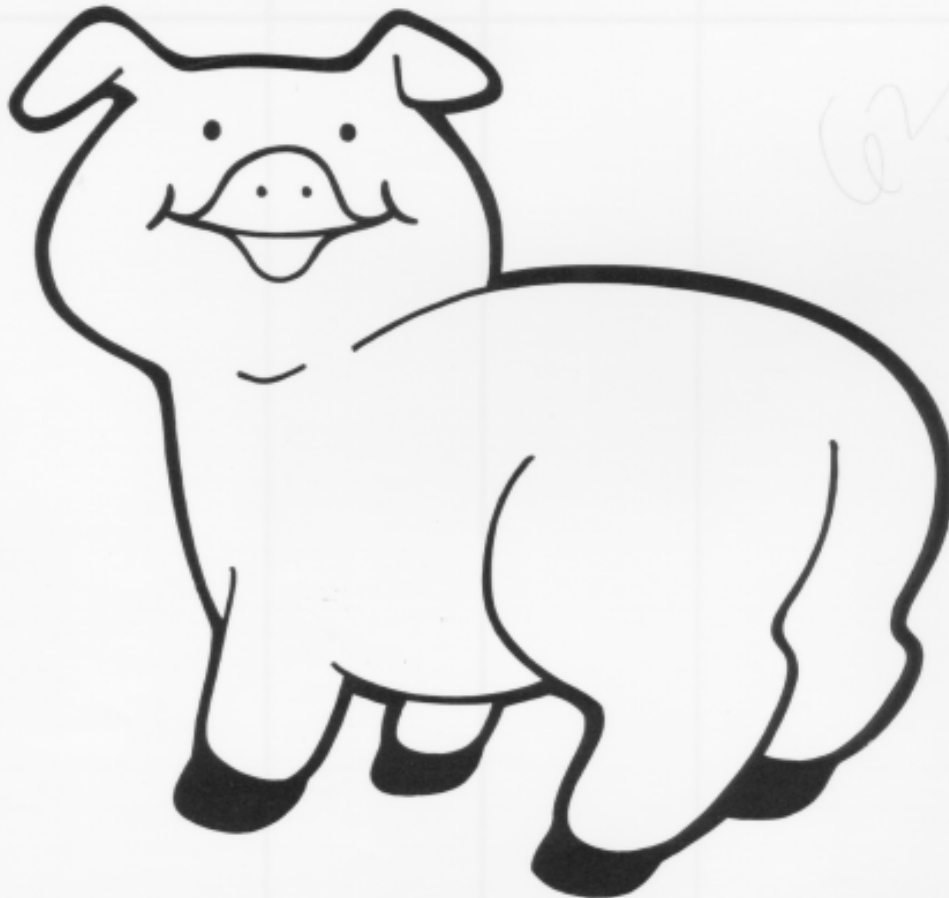
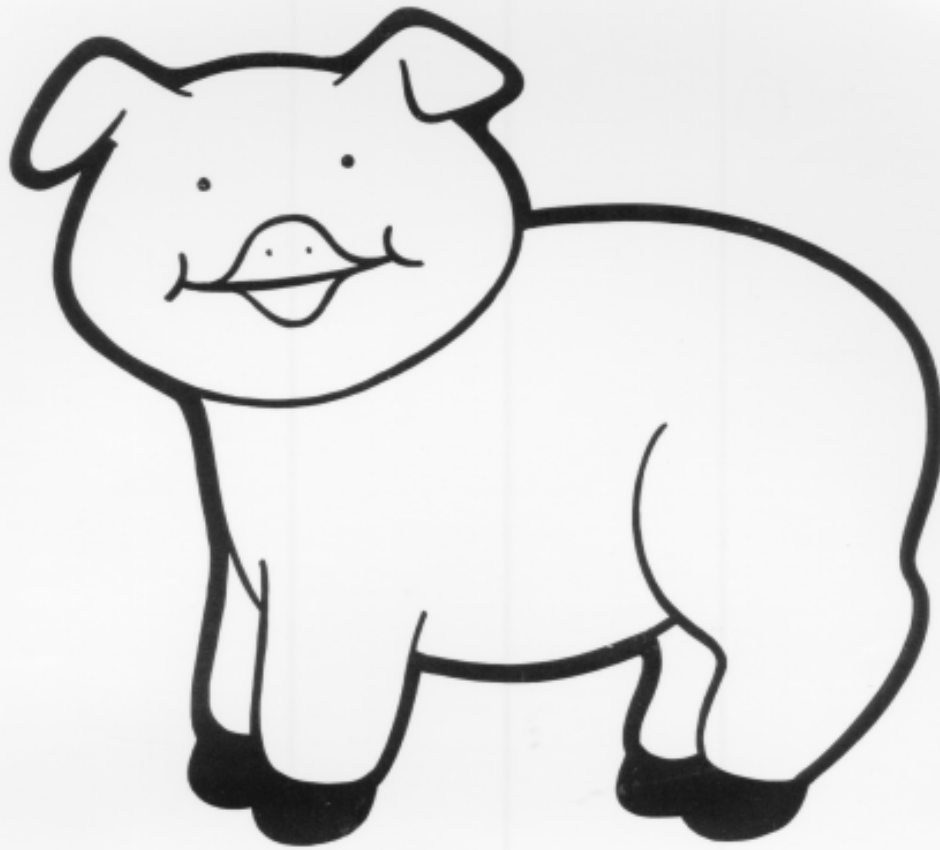

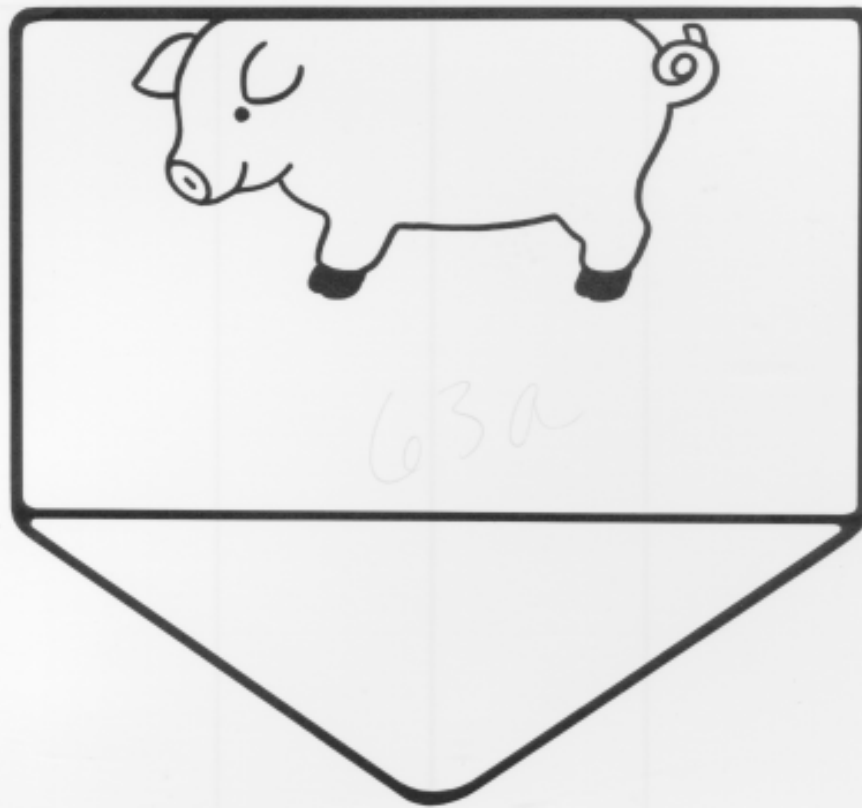

Pattern 34b — Envelope pig

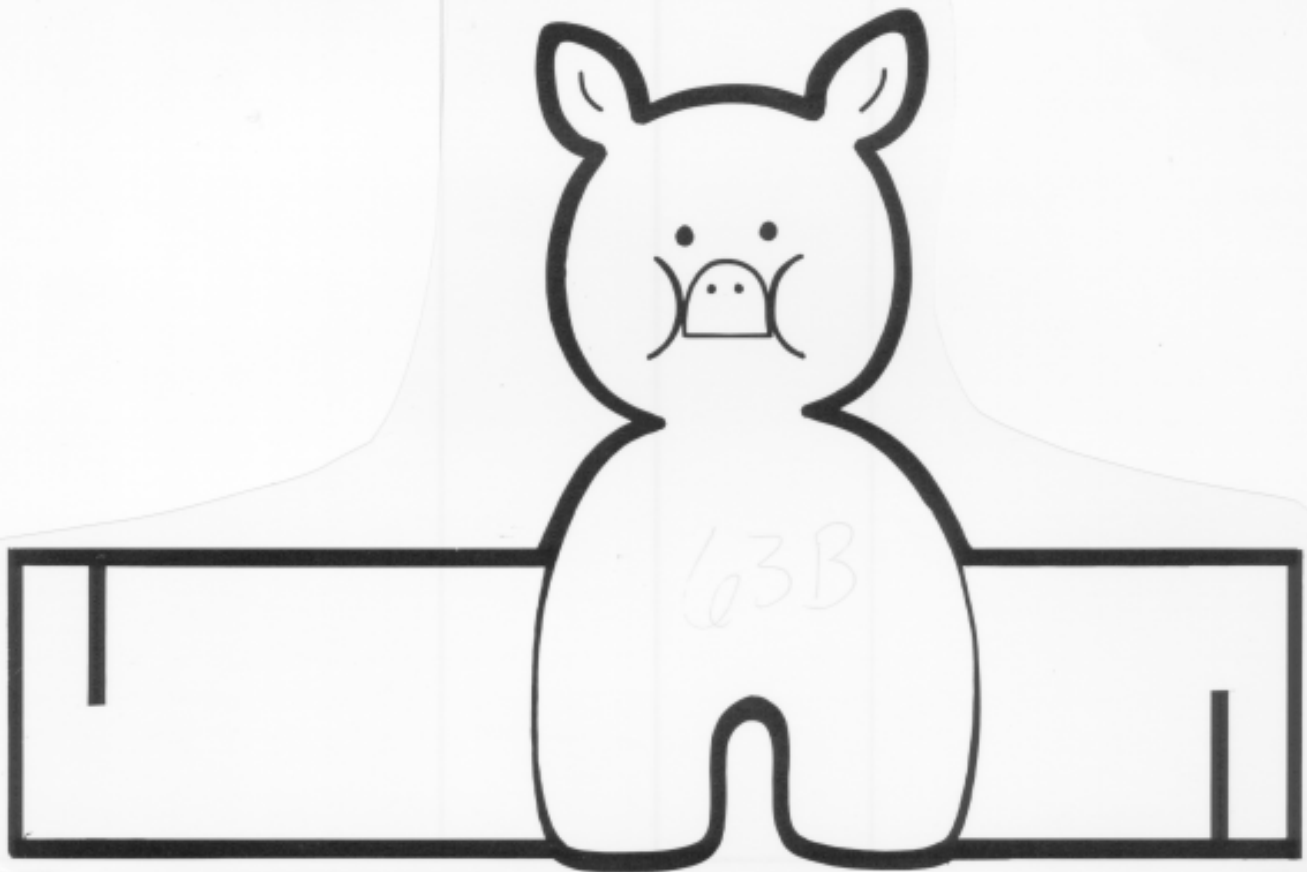

Pattern 34b — Stand-up paper pig



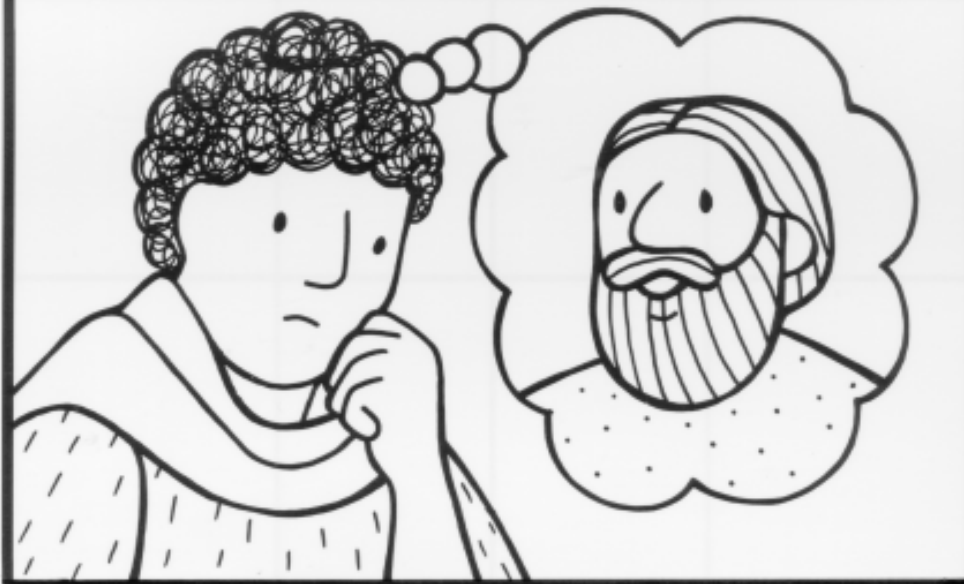

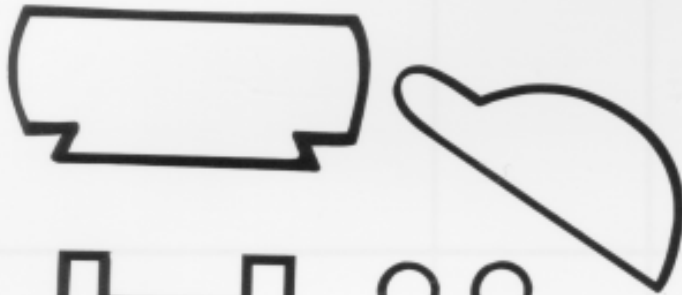
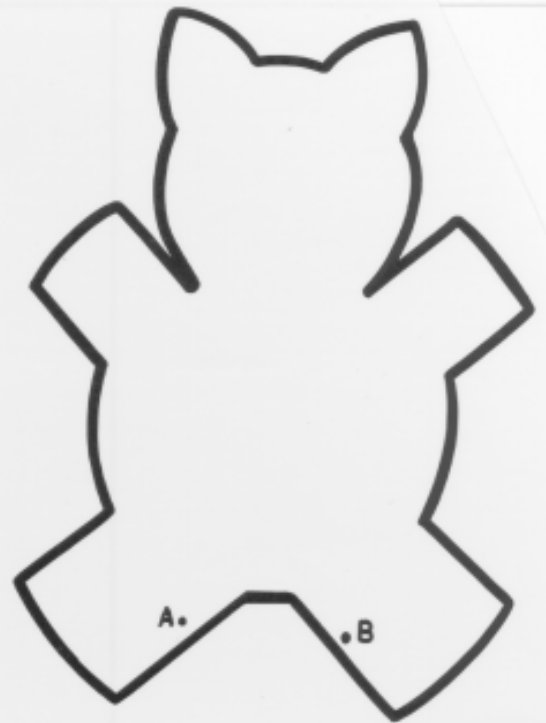

66

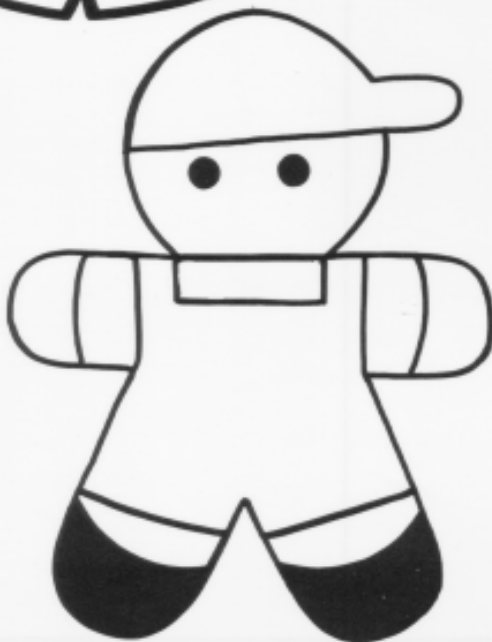

Giving for Jesus

A little girl named Annie learned that when she shared what she had, God used it to make a difference. Read each sentence in the HAVE column, find a NEED to match it, and then find what a DIFFERENCE it made. Think of something you can share and then complete the empty set of boxes at the bottom of the page.

HAVE

NEED

DIFFERENCE

Here is your allowance, Annie.

Helping to clean the church yard is fun. I'm happy when I use my time for Jesus.

People enjoy hearing the children's choir. They sing so well.

Church clean-up day is almost here. Annie, do you have time to help?

It makes me feel good to sing, "Jesus Loves Me," with the children's choir.

Books and pictures were bought to teach other children about Jesus.

Annie, you have a pretty singing voice.

I'll give some money for the missionary work.

The church certainly looks nice when the yard is cleaned up.

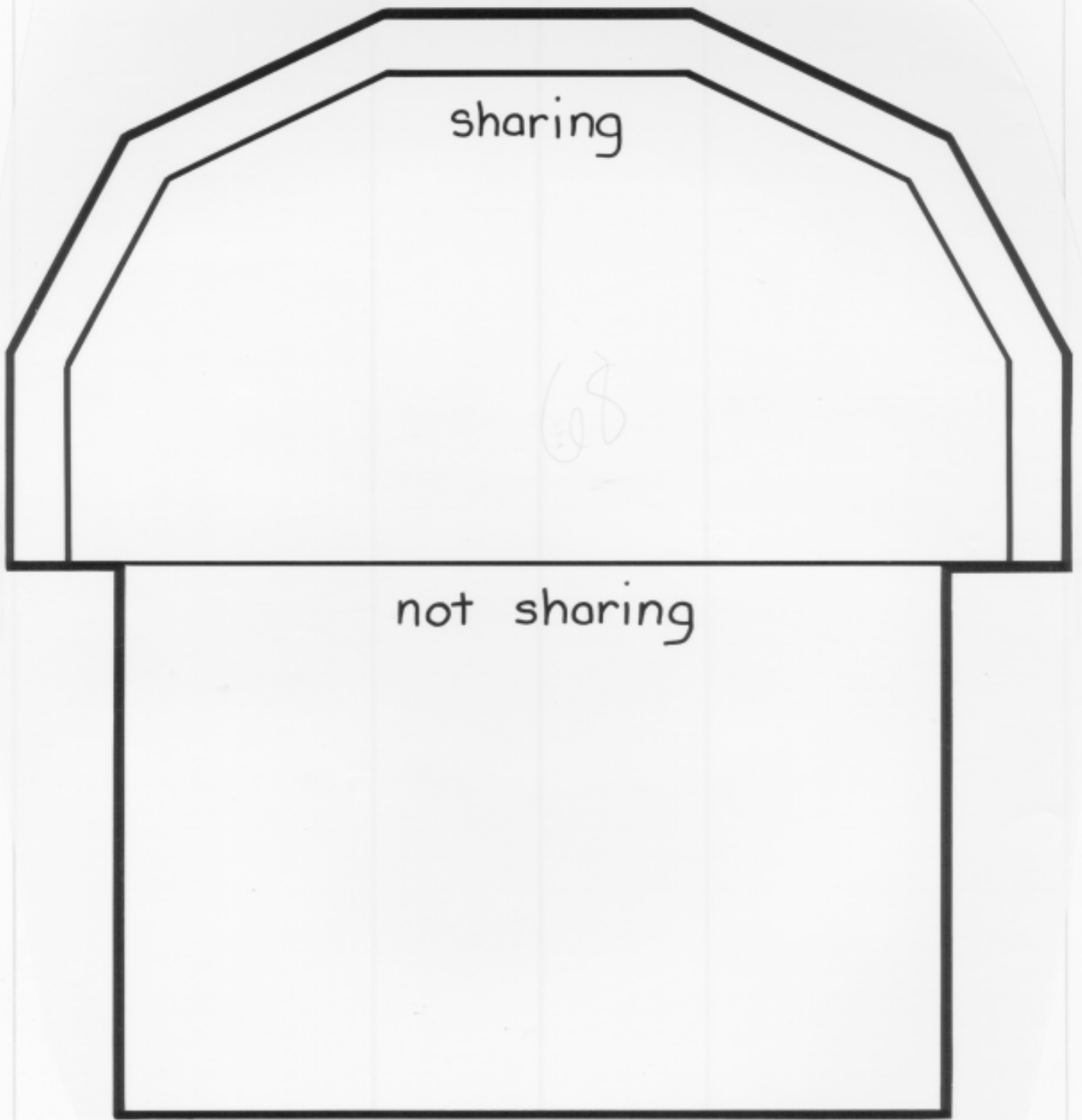

sharing

not sharing

68

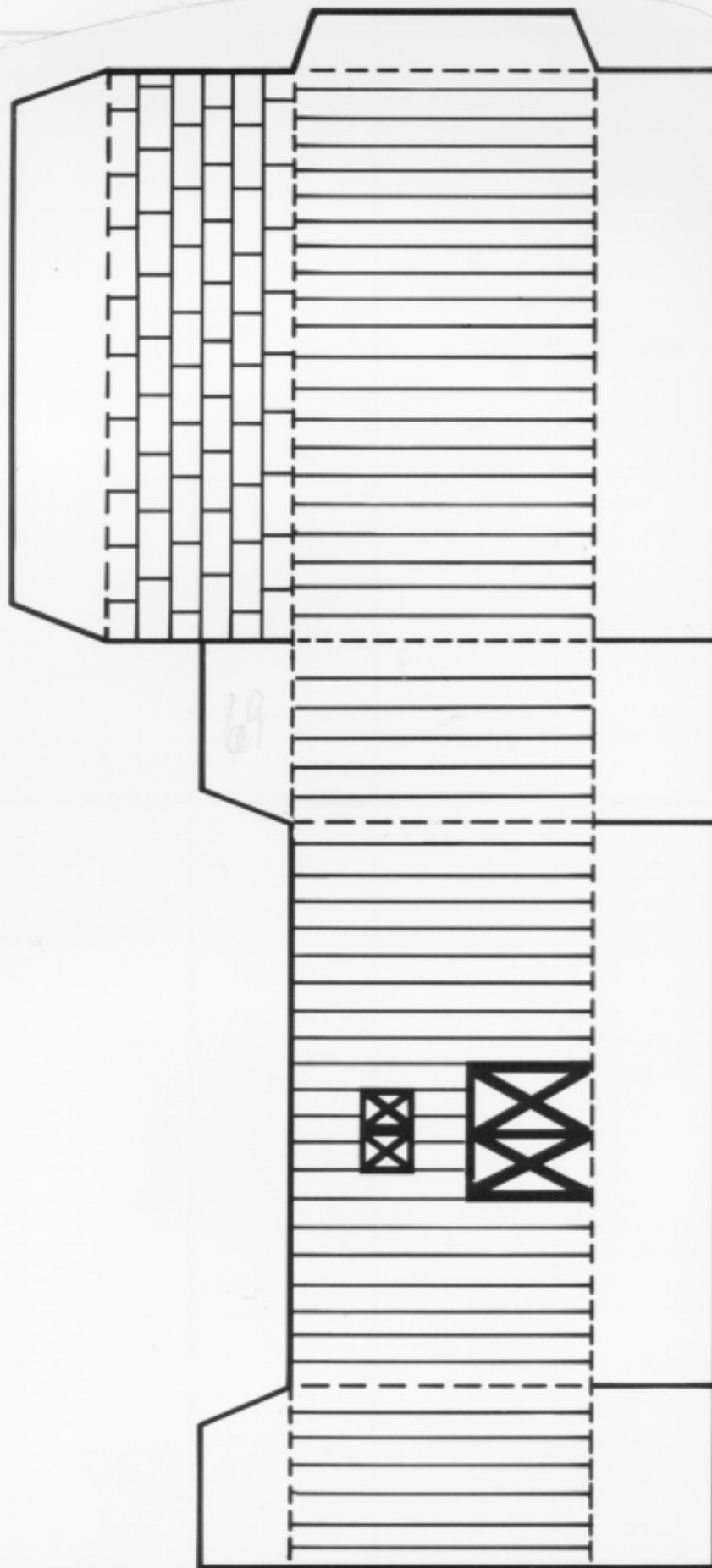

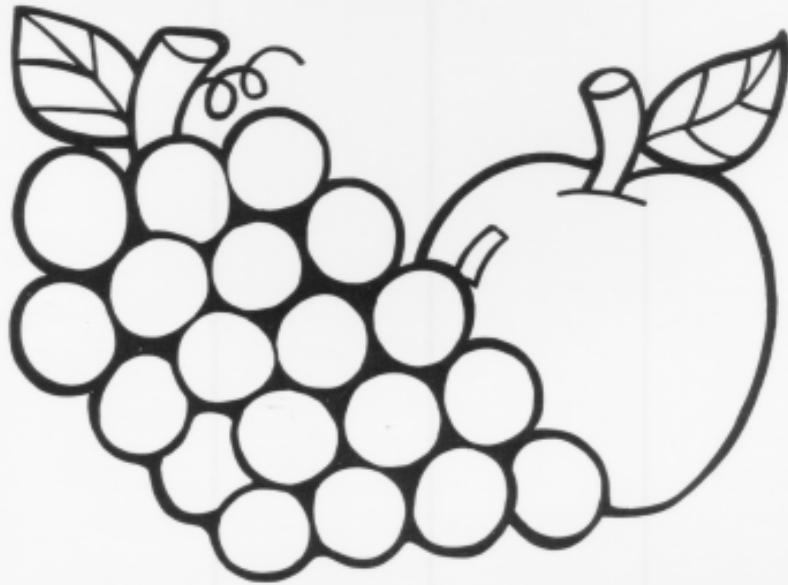



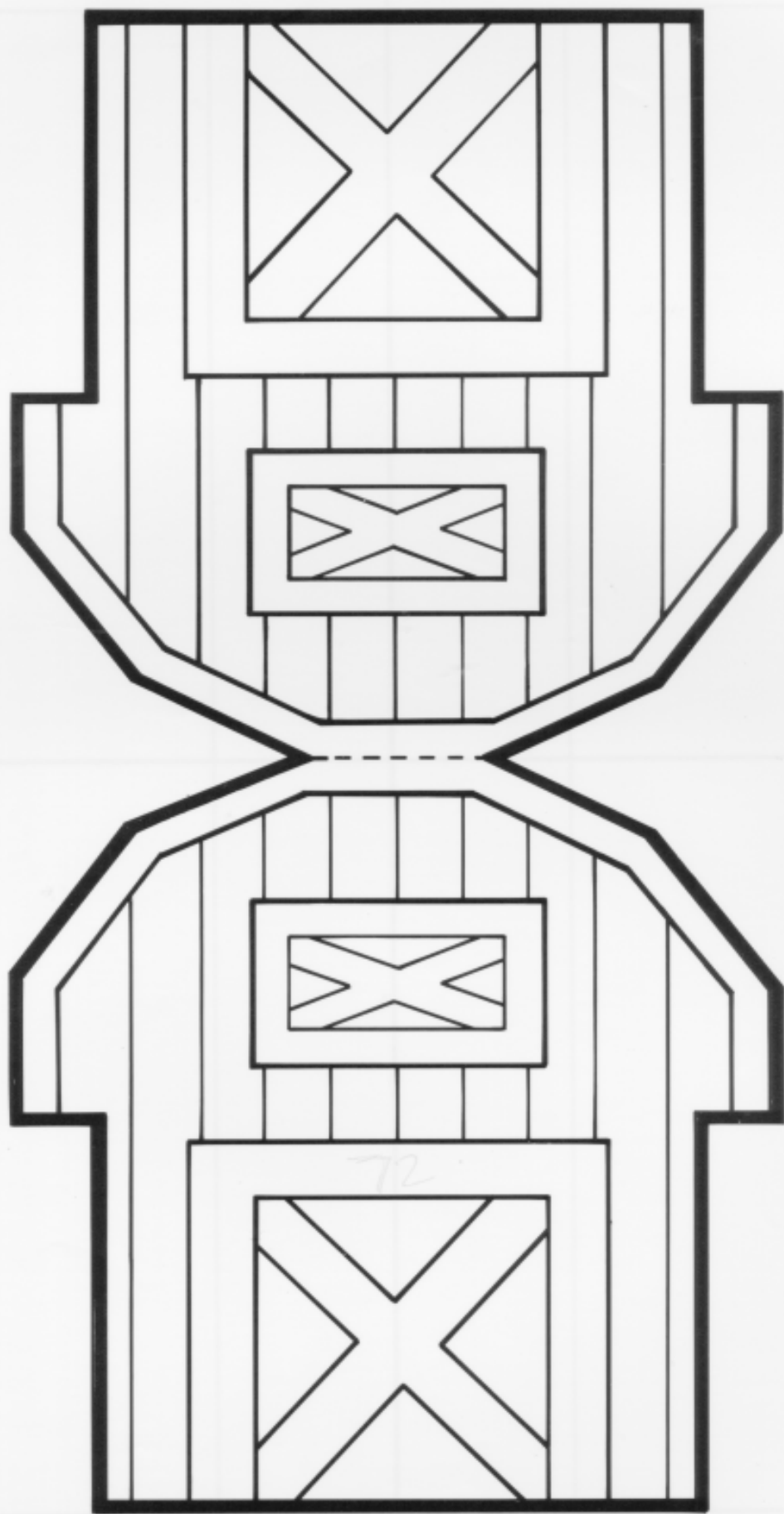

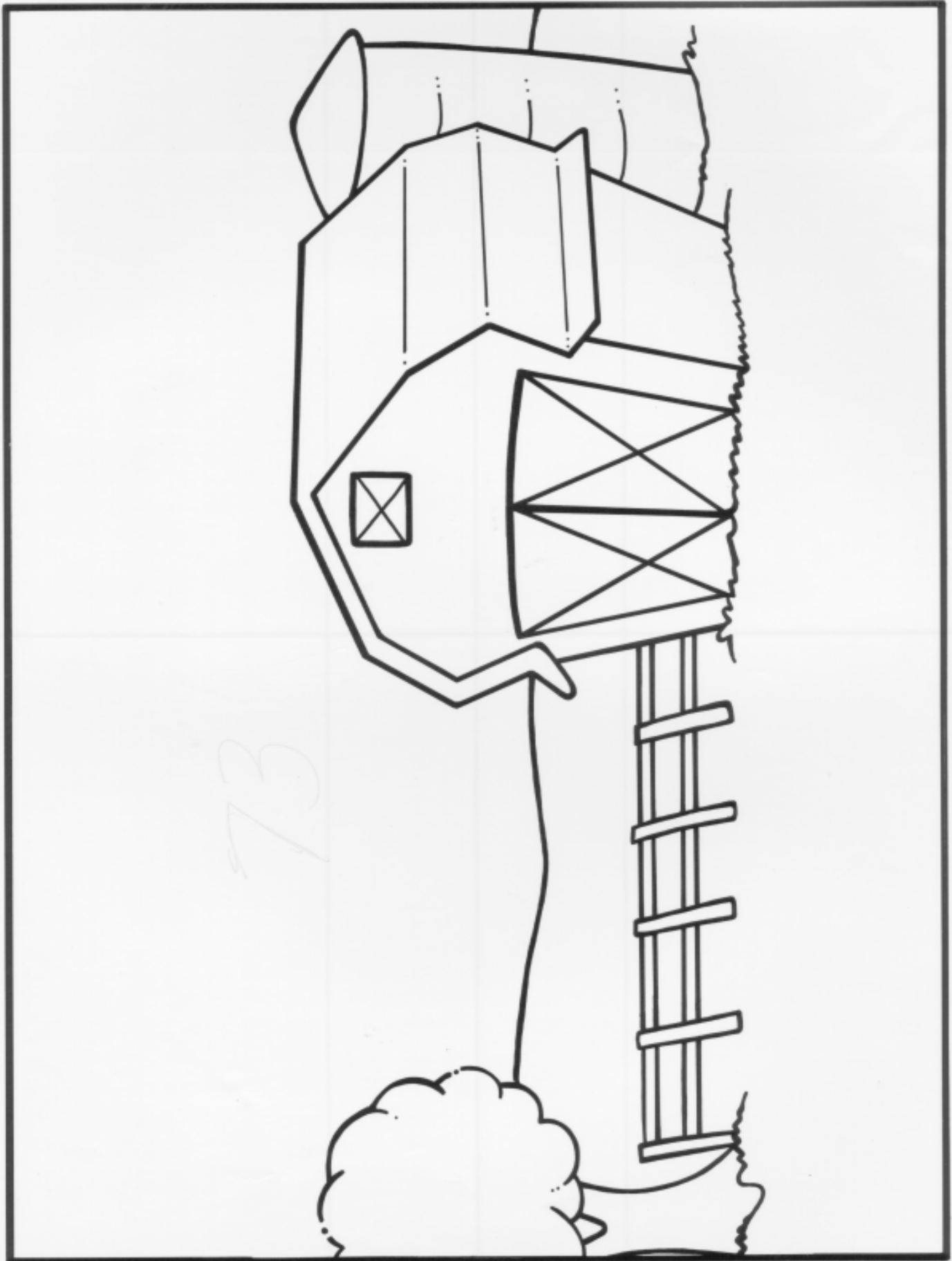

Kindness Coupon

74

Kindness Coupon

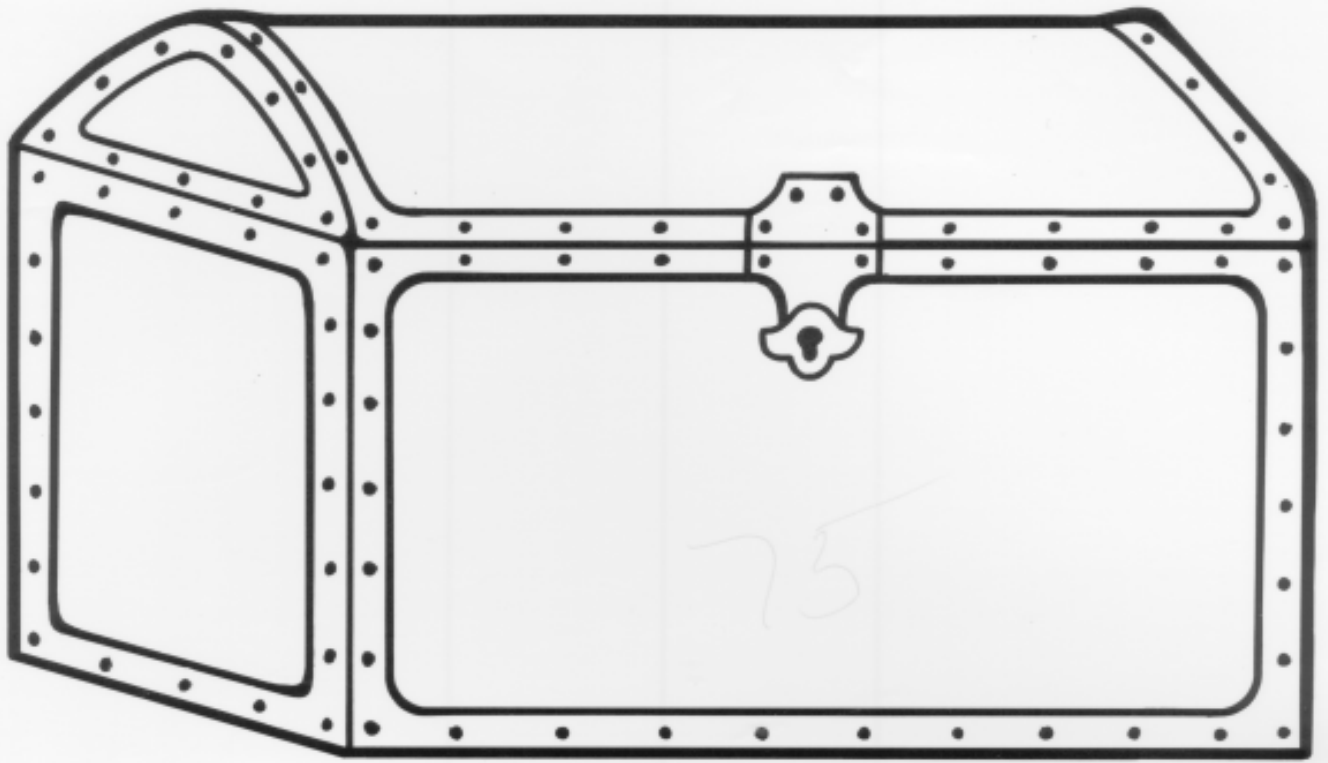

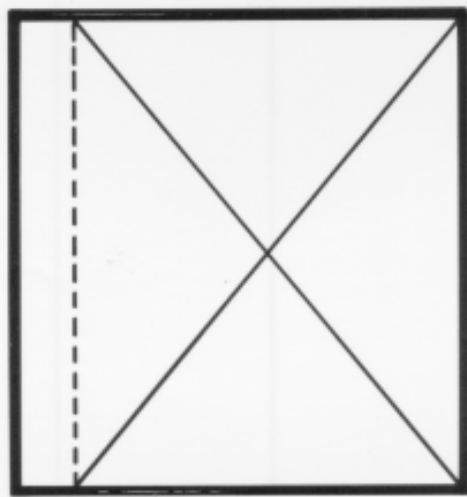
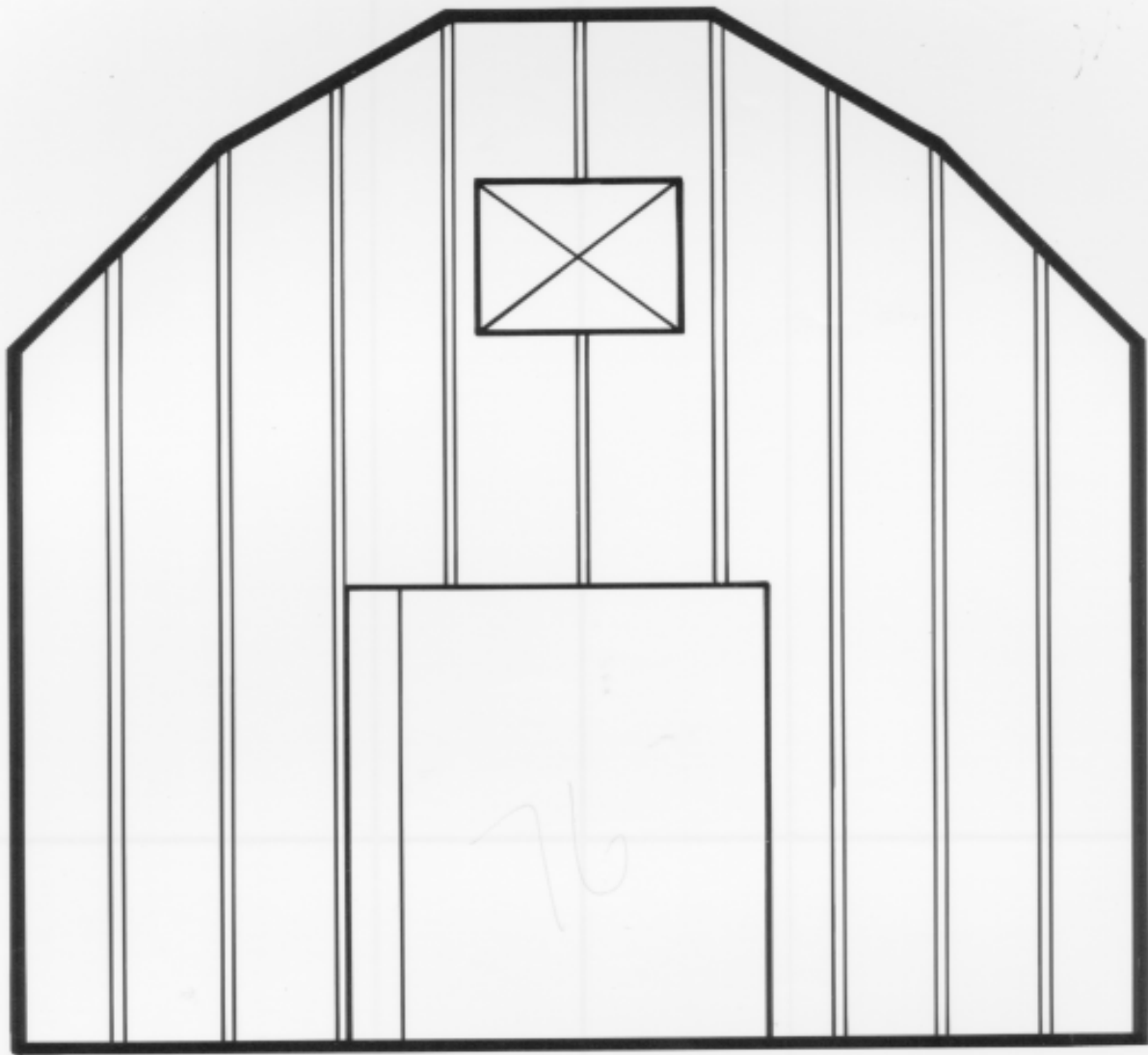



Humble Wheel

x

78

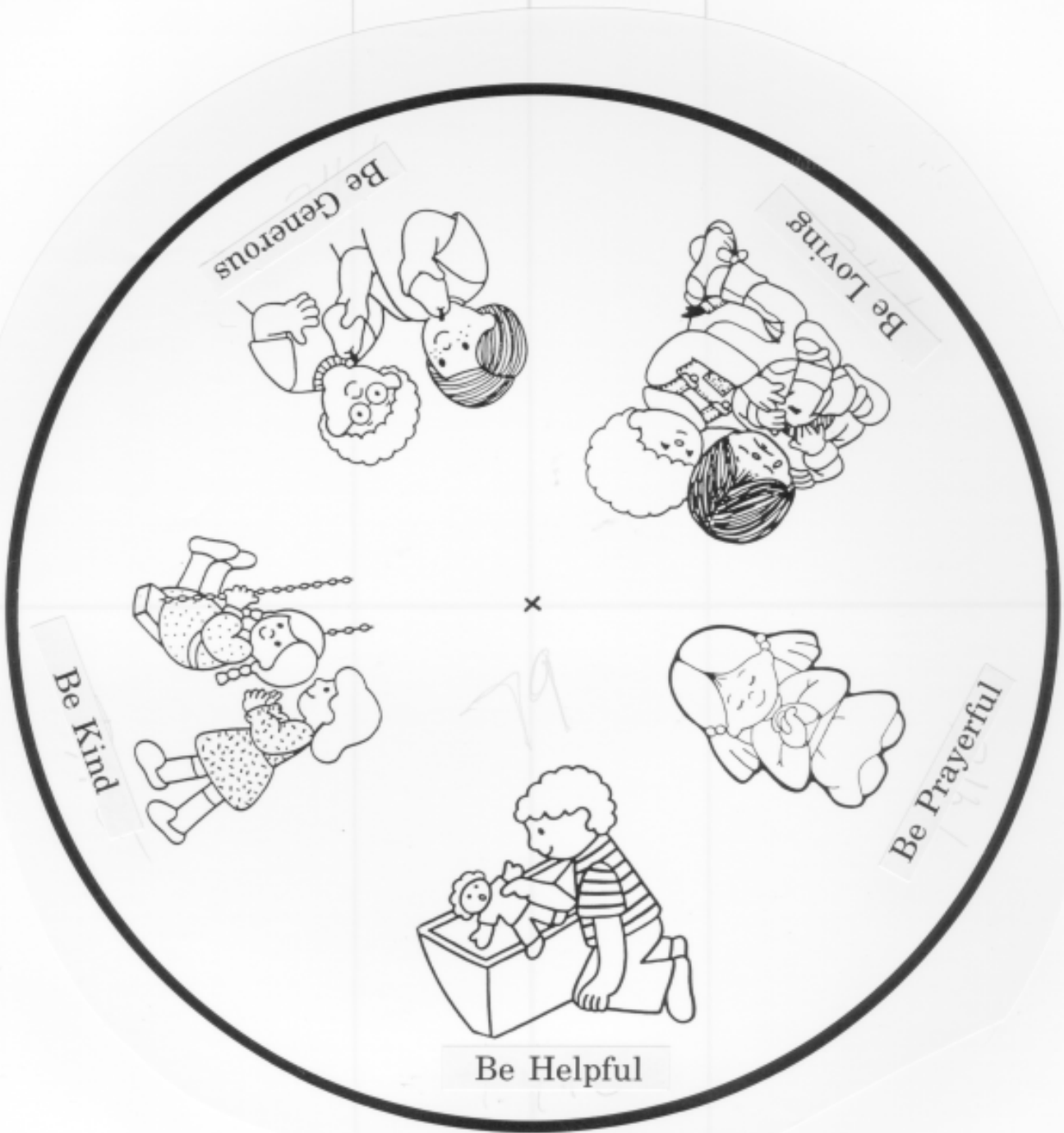



Proud



Humble



Curly



Straight



Big



Little



Happy



81
Sad



Up

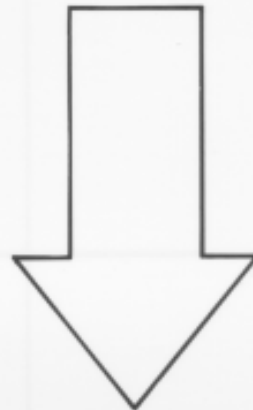

Down



Day



Night



